

BRANDABLE BARS

The technical bits:

1.5 metre bar

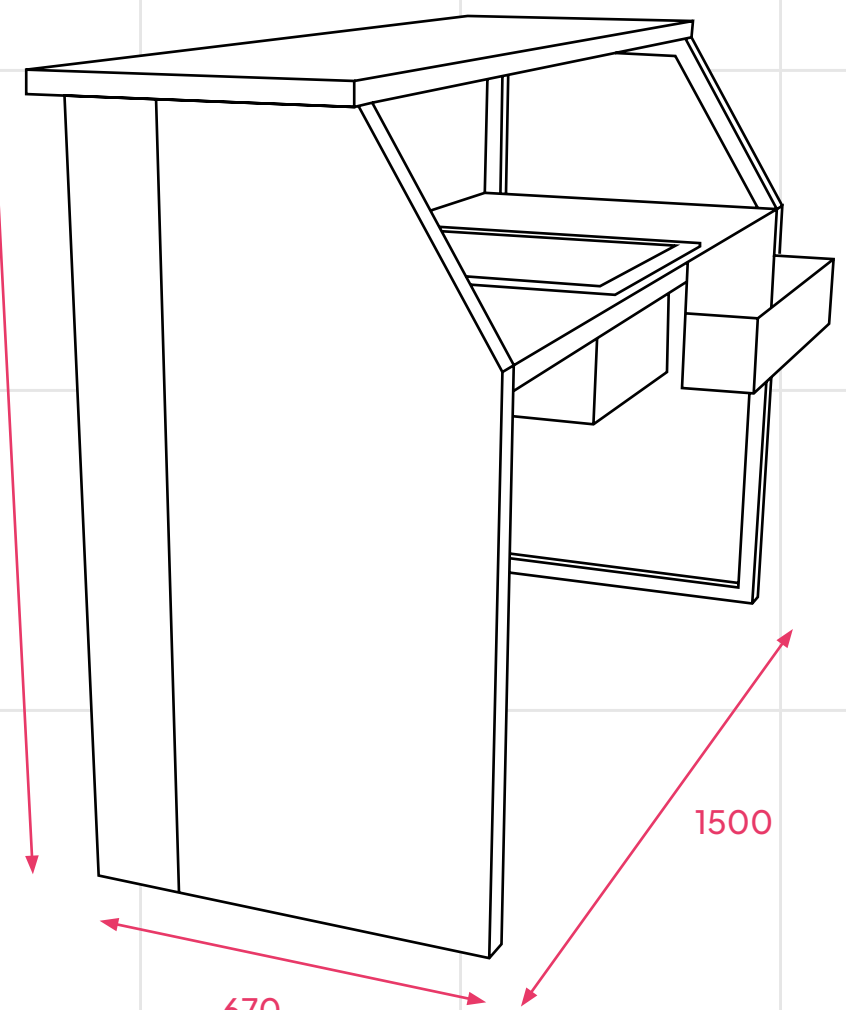

Our barfronts can be customised with graphics (like your company logo).

Overall bar size

Branding the bars:

Please send your artwork in a PDF, JPEG or TIFF format, with all images set to **300dpi and CMYK**.

Please set your artwork to the following dimensions: **1495mm x 1010mm**

Don't have artwork? Please send us your logo in an EPS or Ai format and we'll design the artwork for you.

All measurements are in Millimetres (mm)

BRANDABLE BARS

The technical bits:

3 metre bar

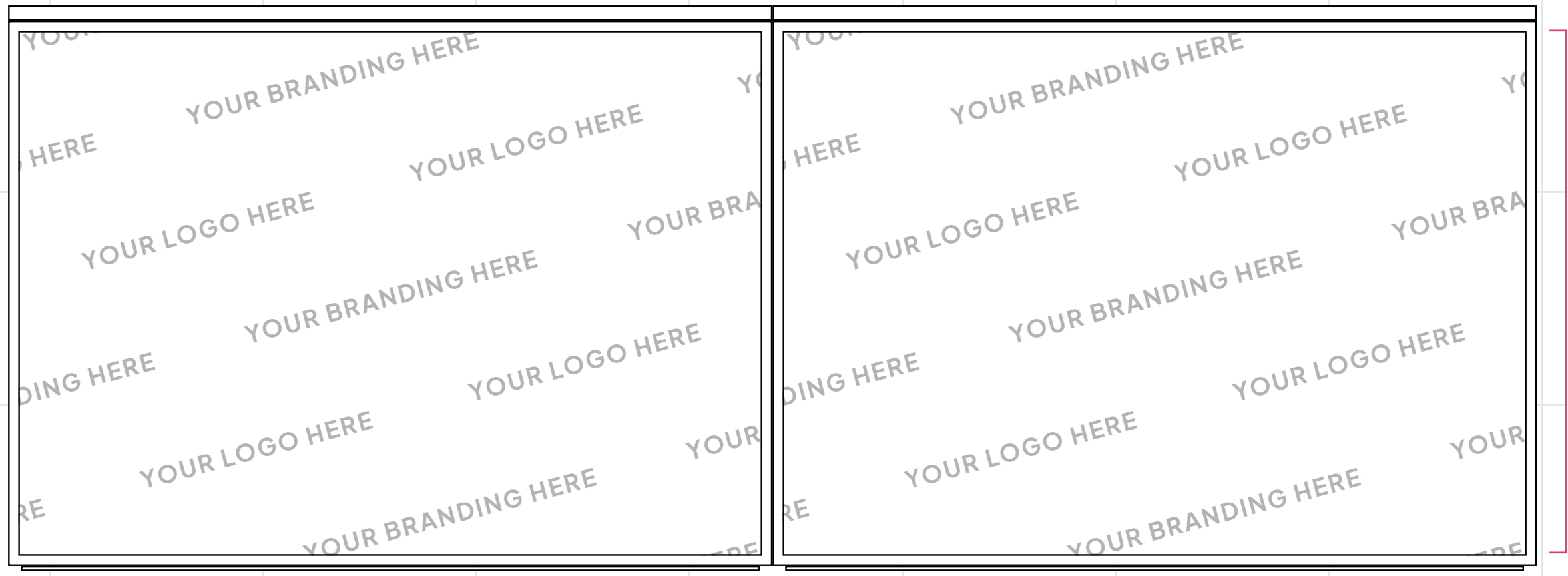
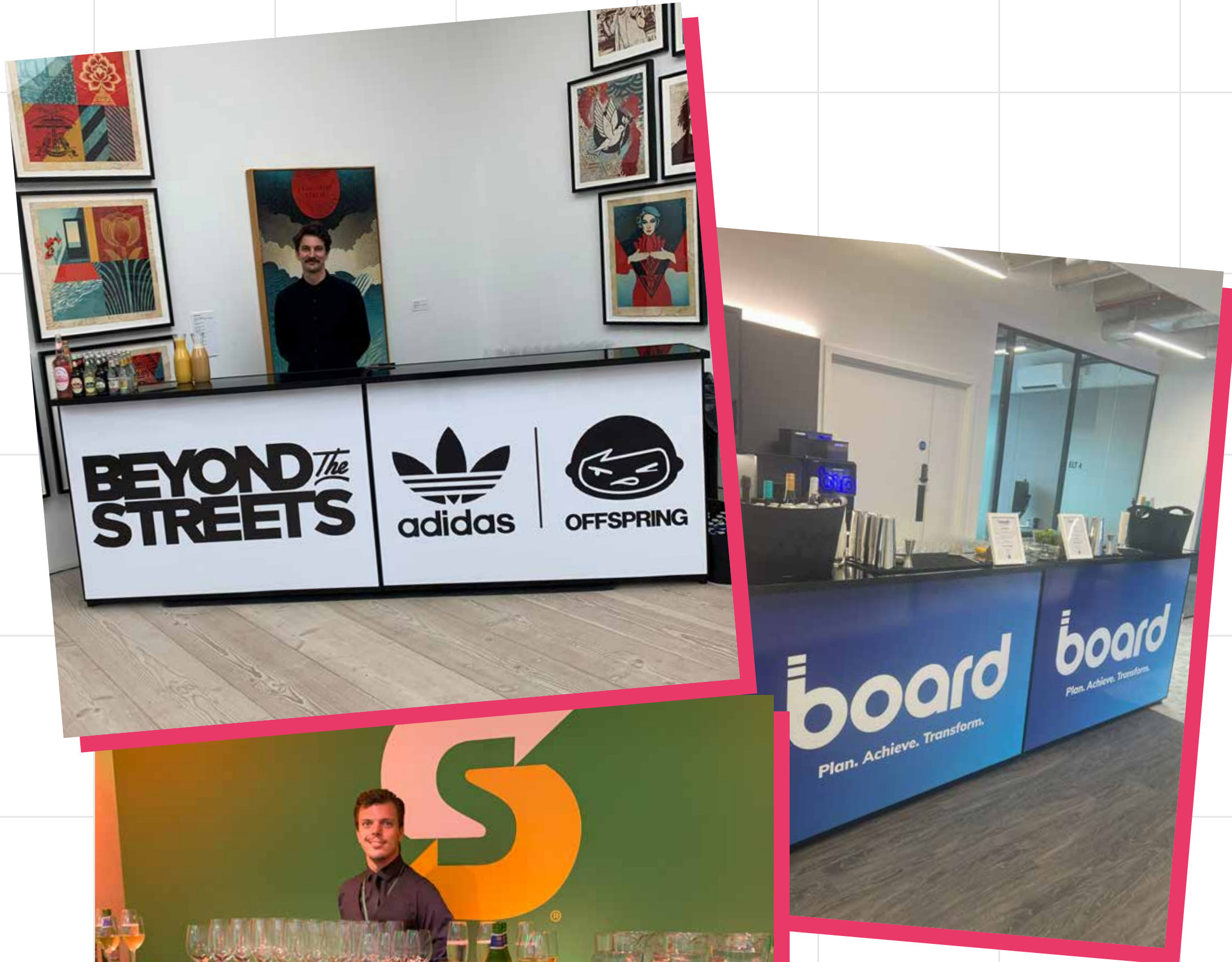

1495

1495

1010

Our barfronts can be customised with graphics (like your company logo).

Branding the bars:

Please send your artwork in a PDF, JPEG or TIFF format, with all images set to **300dpi and CMYK**.

Please set your artwork to the following dimensions: **1495mm x 1010mm**

Don't have artwork? Please send us your logo in an EPS or Ai format and we'll design the artwork for you.

All measurements are in Millimetres (mm)



BRANDABLE BARS

The technical bits:

4.5 metre bar

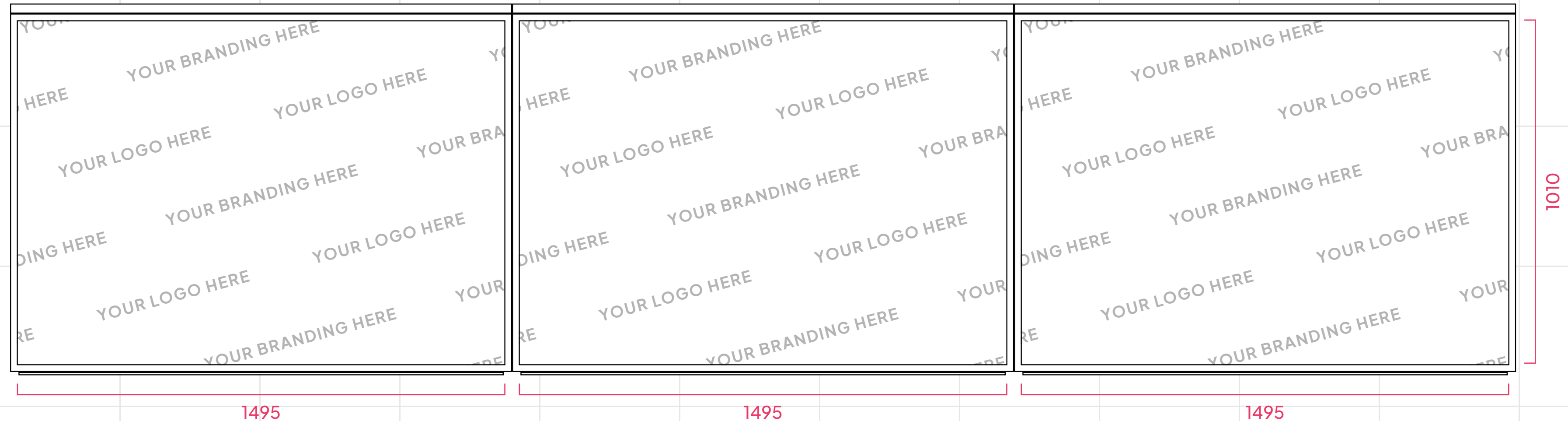

Our barfronts can be customised with graphics (like your company logo).

Branding the bars:

Please send your artwork in a PDF, JPEG or TIFF format, with all images set to **300dpi and CMYK**.

Please set your artwork to the following dimensions: **1495mm x 1010mm**

Don't have artwork? Please send us your logo in an EPS or Ai format and we'll design the artwork for you.



BRANDABLE BARS

Other configurations available:

U-Shaped Bar

(using 3x 1.5metre and 2x corner bar units)

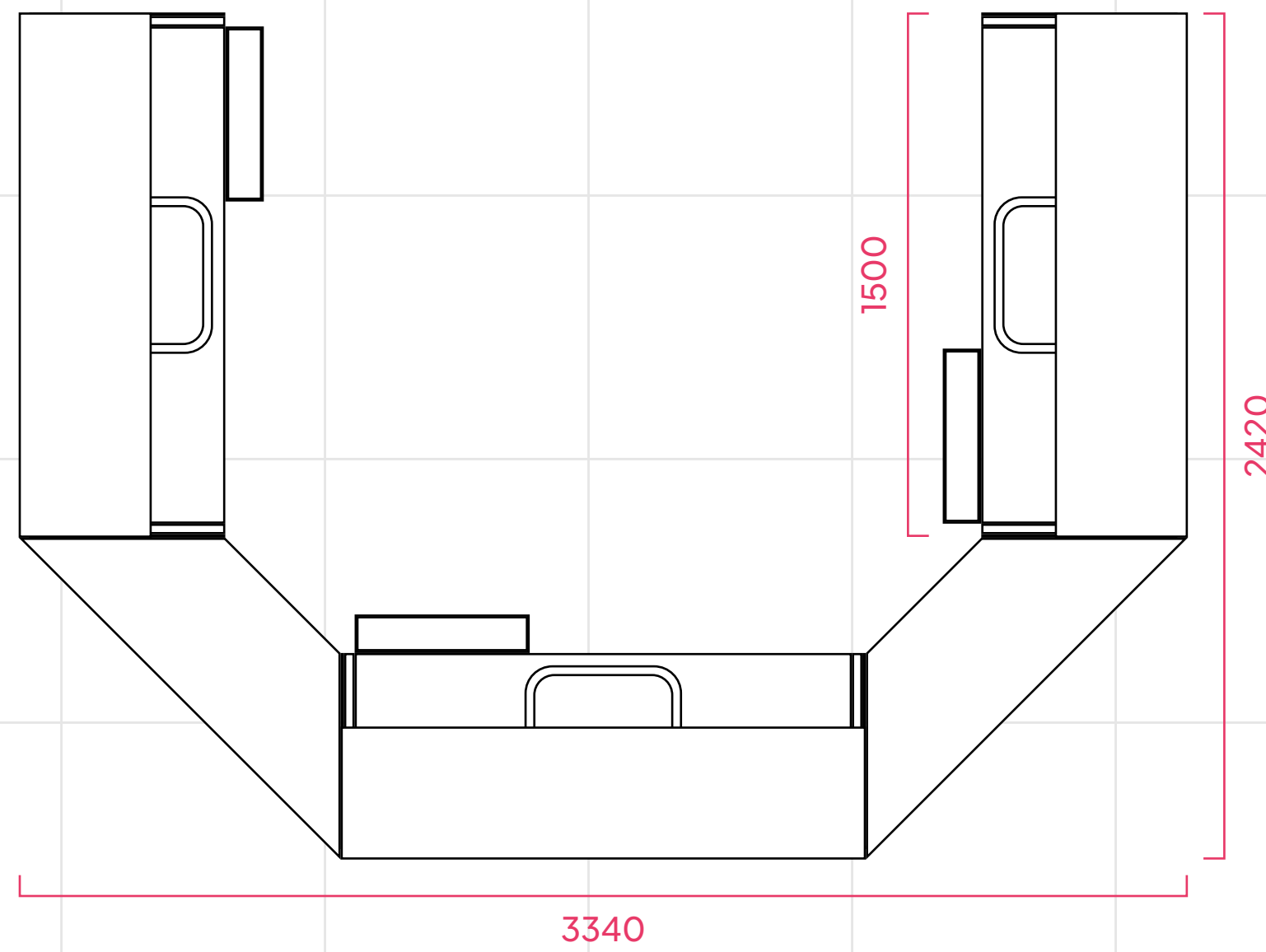

Overall (approx) size:

L-Shaped Bar

(using 2x 1.5metre and 1x corner bar units)

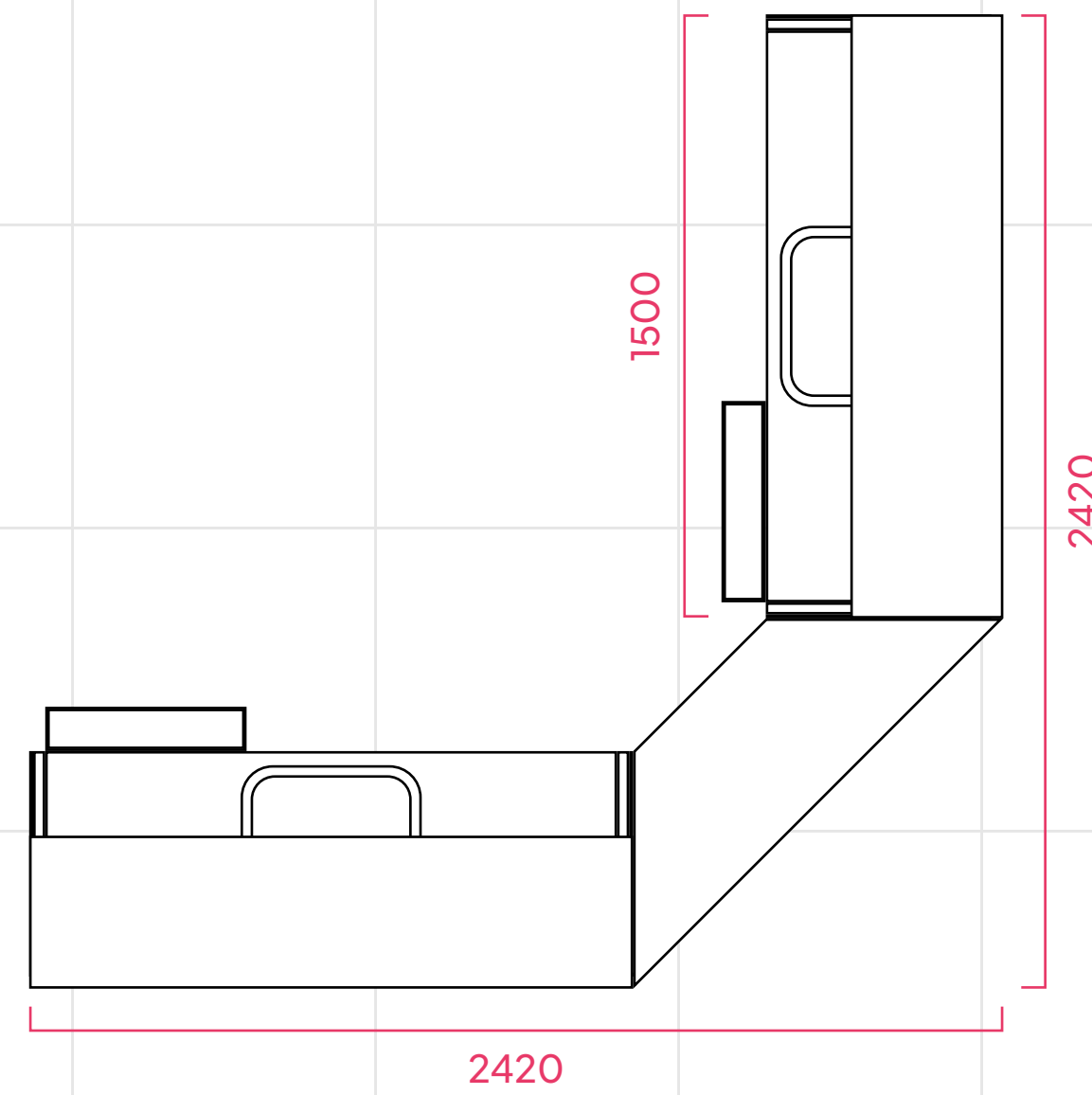

Overall (approx) size:

L-Shaped Bar

(using 3x 1.5metre and 1x corner bar units)

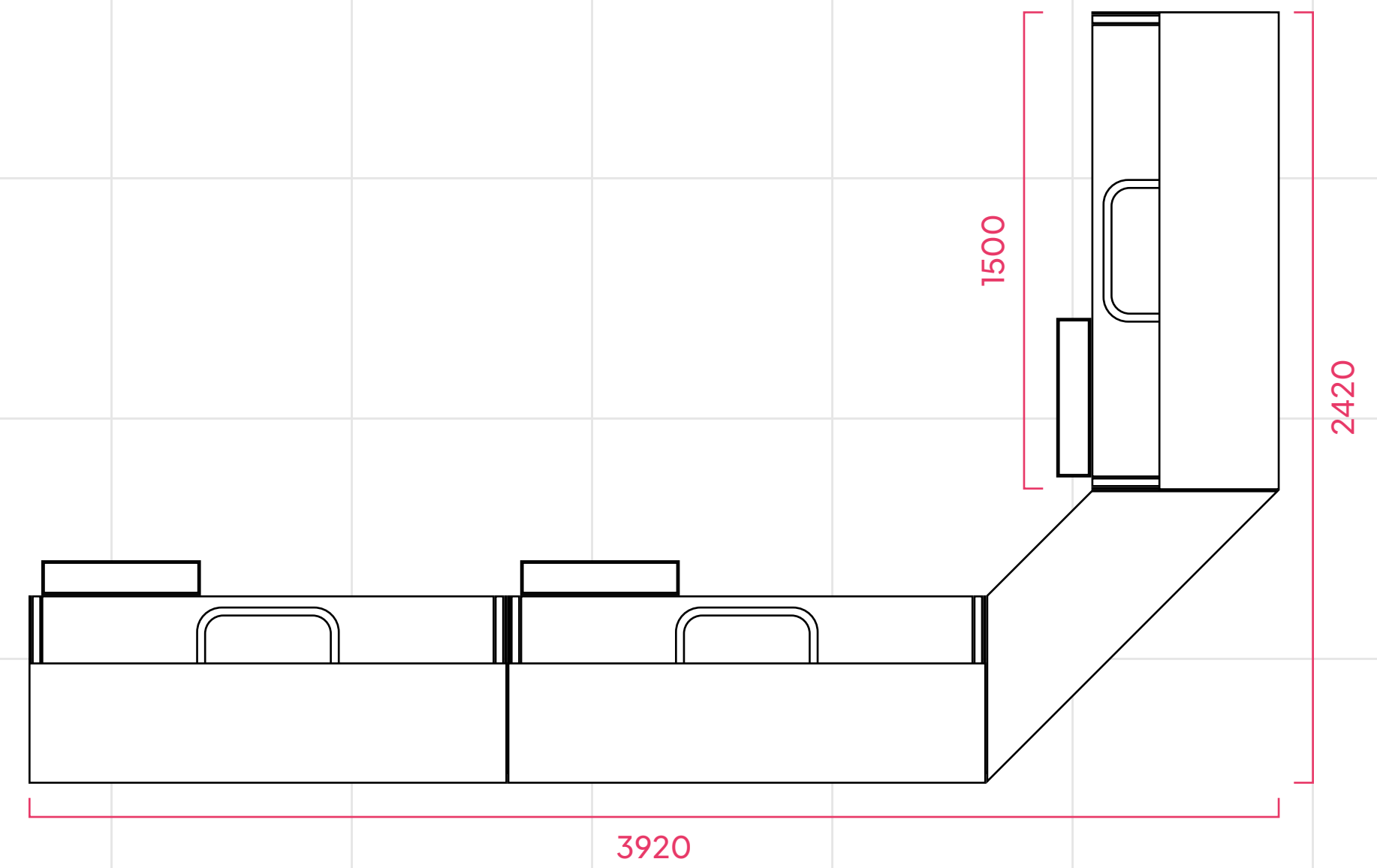

Overall (approx) size:

All measurements are in Millimetres (mm)